

DSK021-021/40-022-023 espositori pubblicitari

SCHEMA TECNICA



DSK021



DSK021/40



DSK022



DSK023

STRUTTURA



MATERIALE STRUTTURA: alluminio



FINITURA MONTANTE: anodizzato silver



FINITURA BASE: verniciata silver RAL 9006



MATERIALE CUBI: metacrilato



FINITURA: trasparente/satinato



INDOOR



SISTEMA DI CHIUSURA

GRAFICA



PERSONALIZZABILE

Cubi autoportanti con piedistallo, in metacrilato trasparente o satinato spessore 4 mm. In tutti i modelli è presente una fessura sul lato superiore e un sistema di chiusura con serratura e chiavi in dotazione. Montante a sezione ovale 70x45mm in alluminio anodizzato silver e base in metallo diametro 450mm verniciata a polveri silver.

DSK021-DSK022-DSK021/40: montante senza tavolino

DSK023: montante con tavolino in metacrilato

DSK021-DSK021/40-DSK023: cubo in metacrilato trasparente e apertura sulla parte superiore

DSK022: cubo in metacrilato satinato e apertura laterale

DSK021-021/40-022-023
 espositori pubblicitari

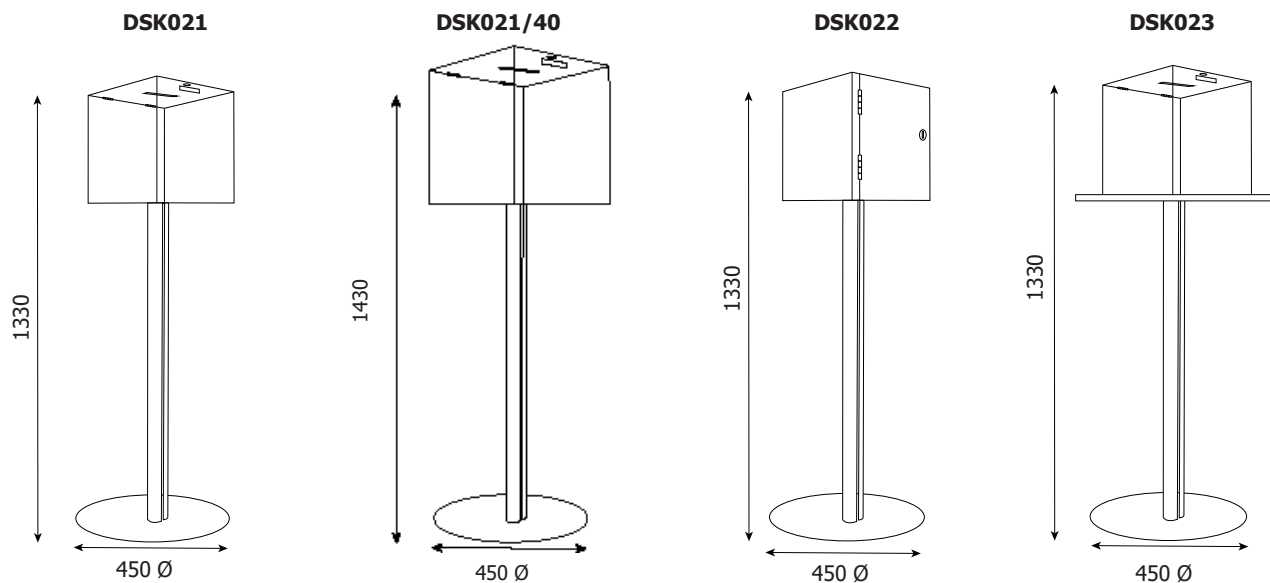
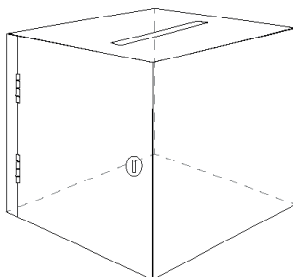
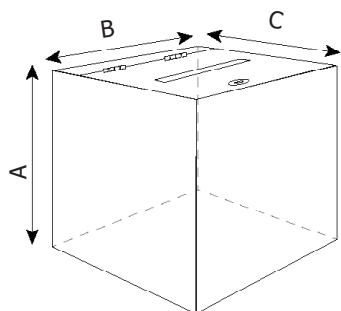
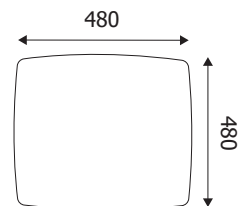
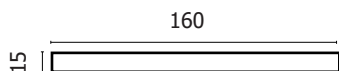
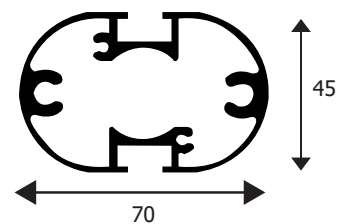
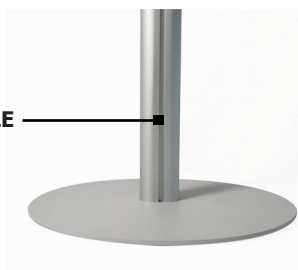
SCHEDA TECNICA

CUBI

TAVOLINO DSK023

FESSURA

MONTANTE OVALE

DIMENSIONI PRODOTTO (mm)

Codice	Dimensioni hxØ	Dimensioni cubo (AxBxC)	Dim. tavolo	Cod. EAN
DSK021	1330x450	300x300x300	-	0755899261604
DSK021/40	1430x550	400x400x400	-	0768855794153
DSK022	1330x450	300x300x300	-	0755899261611
DSK023	1330x450	300x300x300	480x480	0755899261628